

## Assemblage chariot "Enosign"













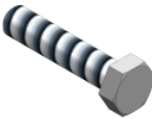

"570282"



"570382"



### Composition du kit

Rep.	Qté	Désignation	Rep.	Qté	Désignation	Rep.	Qté	Désignation
<b>1</b>	2		<b>4</b>	2		<b>T1</b>	1	
			<b>5</b>	2		<b>T2</b>	1	
<b>2</b>	2		<b>6</b>	1				
<b>3</b>	2		<b>7</b>	2				
<b>Enosign 65</b>								
<b>8</b>	2		<b>9</b>	1		<b>10</b>	12	
						<b>11</b>	4	
<b>Enosign 80</b>								
<b>8</b>	4		<b>10</b>	16		<b>11</b>	8	

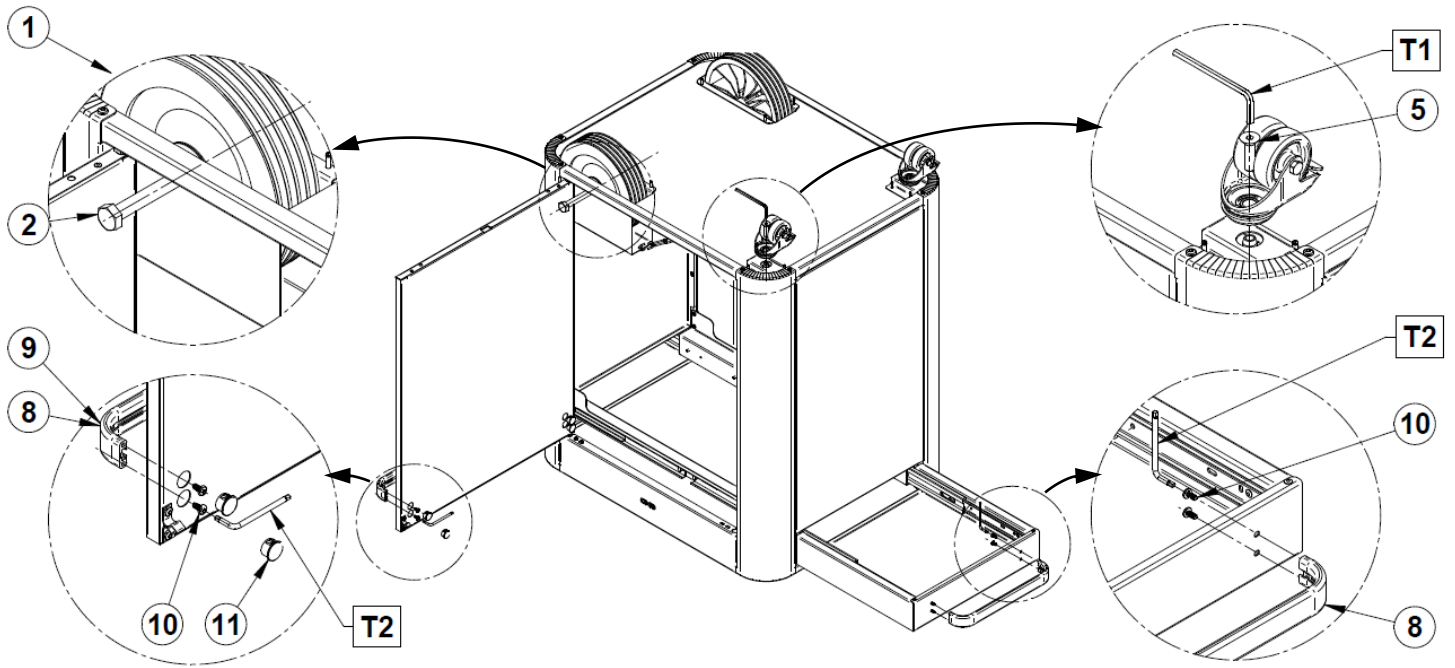

Attention : Avant d'installer la bouteille de gaz dans le chariot, vous devez réaliser le raccordement et l'étanchéité à la bouteille.  
(voir paragraphe III et IV de la notice d'utilisation de la plancha)

